

# CATÁLOGO DE PRODUTOS

PRODUCTS CATALOG

CATALOGUE DE PRODUITS

# 2026

<b>Vedantes e Perfis para Caixilharia de Alumínio/PVC</b> .....	4
Sealants for Aluminium/PVC Holder	
Joints pour Fenêtre d'Aluminium/PVC	
<b>Perfis de Duas Durezas</b> .....	5
Two Hardness Profiles	
Profils de Deux Duretés	
<b>Vedação Central</b> .....	8
Central Sealing	
Joints de Fenêtre	
<b>Batentes</b> .....	10
Door Stop Seals	
Joints de Fenêtre	
<b>Vedantes de Cunha/Aperto</b> .....	13
Wedge Seals	
Joints de Fenêtre	
<b>Vedantes de Correr/ »U «</b> .....	18
Sealing Rods/»U“	
Joints de Fenêtre/»U“	
<b>Vedantes para Utilização Diversa</b> .....	20
Sealants for several uses	
Joints Divers	
<b>Perfis Rijos</b> .....	25
Rigid Profiles	
Profils Rigides	
<b>Vedantes em EPDM</b> .....	28
EPDM Seals	
Joints en EPDM	
<b>Vedação Central</b> .....	29
Central Sealing	
Joints de Fenêtre	
<b>Batentes</b> .....	31
Door Stop Seals	
Joints de Fenêtre	
<b>Vedantes de Cunha/Aperto</b> .....	33
Wedge Seals	
Joints de Fenêtre	
<b>Vedantes Diversos</b> .....	34
Seals for Multiple Uses	
Joints Divers	
<b>Vedantes para Toldos</b> .....	37
Sealing Plates for Awning	
Joints D'Étanchéité pour Auvents	
<b>Vedantes para Caixilharia de Madeira</b> .....	39
Sealing Plates for Wood Furniture	
Joints pour Applications en Bois	
<b>Perfis Rijos Para Vidro</b> .....	45
Rigid Profiles for Glass	
Profils Rifides pour Vitre	
<b>Vedantes e Perfis para Aplicações Específicas</b> .....	48
Sealants and Profiles for Specific Applications	
Joints et Profils pour Applications Spécifiques	
<b>Perfis e Vedantes Técnicos</b> .....	54
Technical Profiles	
Profils Techniques	
<b>Indústria de Frio e Máquinas Industriais</b> .....	59
Cold Industry and Industrial Machinery	
Industrie Froide et Machines Industrielles	
<b>Iluminação Industrial</b> .....	63
Industrial Lighting	
Éclairage Industriel	
<b>Produtos de Injeção</b> .....	65
Injection Area	
Produits d'Injection	

**Observações:**

- ☑ As encomendas consideradas *standard* poderão ser entregues em 3 dias após o seu pedido;
- ☑ Todos os produtos do catálogo poderão ser fabricados na cor mais conveniente para o cliente;
- ☑ Os nossos produtos estão sujeitos a quantidades mínimas de encomenda, variando as mesmas por referência e por cor;
- ☑ Neste catálogo não está representado todo o nosso portfolio de produtos. Para mais informações sobre os mesmos, ou para esclarecimentos sobre a possibilidade de produção de outros perfis, por favor, contate o nosso departamento comercial;
- ☑ Alguns dos produtos aqui apresentados são abrangidos pela nossa cláusula de exclusividade.

**Comments:**

- ☑ Orders considered *standard* can be delivered within 3 days after your order, in Portugal;
- ☑ All products from this catalog can be manufactured in the most convenient color for the customer;
- ☑ Our products are subject to minimum order quantities, varying by reference and color;
- ☑ This catalog does not represent our entire product portfolio. For more information about them, or for clarification about the possibility of producing other profiles, please contact our commercial department;
- ☑ Some of the products presented here are covered by our exclusivity clause.

**Notes:**

- ☑ Les commandes considérées comme *standard* peuvent être expédié dans les 3 jours suivant à votre commande, au Portugal ;
- ☑ Tous les produits du catalogue peuvent être fabriqués dans la couleur la plus convenue pour le client;
- ☑ Nos produits ont des quantités minimum de commande, variant par référence et par couleur;
- ☑ Ce catalogue ne représente pas l'ensemble de notre portefeuille de produits. Pour plus d'informations à leur sujet ou pour obtenir des précisions sur la possibilité de produire d'autres profils, veuillez contacter notre service commercial.
- ☑ Certains produits présentés ici sont couverts par notre clause d'exclusivité.

## VEDANTES FLEXÍVEIS PARA CAIXILHARIA DE ALUMÍNIO/PVC





















FLEXIBLE SEALANTS FOR ALUMINUM/PVC HOLDER  
JOINTS FLEXIBLES POUR FENÊTRE D'ALUMINIUM/PVC

















































**PERFIS DE DUAS DUREZAS**  
**TWO HARDNESS PROFILES**  
**PROFILS DE DEUX DURETÉS**

NOTA: Os perfis de duas durezas estão disponíveis com bases de diversas medidas  
NOTE: The profiles of two hardnesses are available with various base measures  
NOTE: Les profils de deux duretés sont disponibles avec des bases de différentes mesures





















 <b>REF 456</b>	 <b>REF 456 F</b>	 <b>REF 456 FF</b>	 <b>REF 456 FFF</b>
 <b>REF 456FB</b>	 <b>REF 457</b>	 <b>REF 458</b>	 <b>REF 472</b>
 <b>REF 479</b>	 <b>REF 479 B</b>	 <b>REF 479 F</b>	 <b>REF 480</b>
 <b>REF 488</b>	 <b>REF 492</b>	 <b>REF 496</b>	 <b>REF 504</b>
 <b>REF M504</b>	 <b>REF 506</b>	 <b>REF 506 B</b>	 <b>REF 506 F</b>

 REF 506 FF	 REF 507	 REF 507 B	 REF 507 F
 REF M507	 REF 508	 REF 508 F	 REF 508 FF
 REF 511	 REF M511	 REF 512	 REF 513
 REF 513 B	 REF 513 BF	 REF 513 F	 REF 514
 REF 515	 REF 515 B	 REF 515 F	 REF 516
 REF 516 F	 REF 516 FB	 REF 521	 REF 522

 REF 522 F	 REF 523	 REF 534	 REF 536
 REF 542	 REF 548	 REF 578	 REF 582
 REF 583	 REF 688	 REF 756	 REF 771
 REF 801	 REF 805	 REF 893	 REF 916
 REF 929	 REF 944	 REF 1038	 REF 1091
 REF 1136			























**VEDAÇÃO CENTRAL**  
CENTRAL SEALING  
JOINTS DE FENÊTRE

























 <b>REF 417</b>	 <b>REF 417 F</b>	 <b>REF 417 FF</b>	 <b>REF 447</b>
 <b>REF 447 F</b>	 <b>REF 453</b>	 <b>REF 453 TPS</b>	 <b>REF 462</b>
 <b>REF 462 TPS</b>	 <b>REF 462 F</b>	 <b>REF 465</b>	 <b>REF 465 F</b>
 <b>REF 502</b>	 <b>REF 502 B</b>	 <b>REF 502 F</b>	 <b>REF 502 FF</b>
 <b>REF 524</b>	 <b>REF 528</b>	 <b>REF 530</b>	 <b>REF 535</b>



















**BATENTES**  
DOOR STOP SEALS  
JOINTS DE FENÊTRE





















 <b>REF 225</b>	 <b>REF 225 B</b>	 <b>REF 225 CA</b>	 <b>REF 242</b>
 <b>REF 246</b>	 <b>REF 246 B</b>	 <b>REF 250</b>	 <b>REF 256</b>
 <b>REF 259</b>	 <b>REF 265</b>	 <b>REF 265 B</b>	 <b>REF 265 F</b>
 <b>REF 265 FB</b>	 <b>REF 266</b>	 <b>REF 268</b>	 <b>REF 268 F</b>
 <b>REF 268 FF</b>	 <b>REF 325</b>	 <b>REF 328</b>	 <b>REF 328 A</b>













 REF 328 F	 REF 360	 REF 375	 REF 375 B
 REF 378	 REF 386	 REF 388	 REF 390
 REF 391	 REF 392	 REF 394	 REF 400
 REF 401	 REF 418	 REF 420	 REF 426
 REF 426 B	 REF 426 F	 REF 426 FF	 REF 440
 REF 449	 REF 450	 REF 450 B	 REF 450 F

























 REF 463	 REF 463 F	 REF 463 TPS	 REF 464
 REF 464 F	 REF 464 TPS	 REF 517	 REF 517 B
 REF 517 F	 REF 517 FF	 REF 588	 REF 590
 REF 591	 REF 608		







**VEDANTES DE CUNHA/APERTO**  
WEDGE SEALS  
JOINTS DE FENÊTRE

 <b>REF 223</b> (4,3mm)	 <b>REF 223 B</b> (4,5mm)	 <b>REF 223 BF</b> (4,8mm)	 <b>REF 223 BFM</b> (5,3mm)
 <b>REF 223 BFM+</b> (6,1mm)	 <b>REF 223 F</b> (3,5mm)	 <b>REF 223 FF</b> (2,7mm)	 <b>REF 223 FFF</b> (2,1mm)
 <b>REF 223 FFFF</b> (1,8mm)	 <b>REF 223 FFFFF</b> (1,7mm)	 <b>REF 223 FB</b> (3,9mm)	 <b>REF 226</b>
 <b>REF 234</b> (3,3mm)	 <b>REF 234 B</b> (3,6mm)	 <b>REF 235</b> (2,8mm)	 <b>REF 235 B</b> (3,3mm)
 <b>REF 235 BF</b> (4mm)	 <b>REF 235 BFM</b> (4,5mm)	 <b>REF 251</b> (3,3mm)	 <b>REF 252</b> (3,9mm)

 <b>REF 314</b> (3,3mm)	 <b>REF 314 B</b> (3,5mm)	 <b>REF 314 BF</b> (3,8mm)	 <b>REF 314 BFM</b> (4,4mm)
 <b>REF 314 F</b> (3mm)	 <b>REF 315</b> (3,3mm)	 <b>REF 315 B</b> (3,5mm)	 <b>REF 315 F</b> (2,2mm)
 <b>REF 315 FF</b> (1,8mm)	 <b>REF 315 FFF</b> (1,7mm)	 <b>REF 316</b> (1,8mm)	 <b>REF 316 B</b> (2,4mm)
 <b>REF 316 BF</b> (3mm)	 <b>REF 316 F</b> (1,5mm)	 <b>REF 316 FF</b> (1,4mm)	 <b>REF 323</b> (3,5mm)
 <b>REF 393</b>	 <b>REF 402</b> (2,1mm)	 <b>REF 403</b> (3mm)	 <b>REF 404</b> (3mm)
 <b>REF 405</b> (3mm)	 <b>REF 406</b> (5,5mm)	 <b>REF 406 B</b> (6,1mm)	 <b>REF 406 BF</b> (7,4mm)





















 <b>REF 410</b>	 <b>REF 410 F</b>	 <b>REF 410 FBB</b>	 <b>REF 429 (1,9mm)</b>
 <b>REF 429 B (2,3mm)</b>	 <b>REF 429 F (1,7mm)</b>	 <b>REF 432</b>	 <b>REF M432</b>
 <b>REF 432 F</b>	 <b>REF 432 FF</b>	 <b>REF 437 (5,5mm)</b>	 <b>REF 452</b>
 <b>REF 469 (3mm)</b>	 <b>REF 469 B (3,5mm)</b>	 <b>REF 469 F (2,5mm)</b>	 <b>REF 469 F+ (2,5mm)</b>
 <b>REF 470 (3,7mm)</b>	 <b>REF 470 B (4,2mm)</b>	 <b>REF 470 F (3,1mm)</b>	 <b>REF 470 FB (3,5mm)</b>
 <b>REF 471 (4,3mm)</b>	 <b>REF 474 (5,7mm)</b>	 <b>REF 475</b>	 <b>REF 476 (5,7mm)</b>





















			
<b>REF 482</b> (6,7mm)	<b>REF 509</b>	<b>REF 509 B</b>	<b>REF 509 F</b>
			
<b>REF 509 TPS</b>	<b>REF 537</b>	<b>REF 581</b> (2,3mm)	<b>REF 581 B</b> (2,5mm)
			
<b>REF 581 F</b> (2,1mm)	<b>REF 581 FF</b> (1,6mm)	<b>REF 585</b>	<b>REF M585</b>
			
<b>REF 613</b> (3mm)	<b>REF 613 F</b> (2,5mm)	<b>REF 820</b> (6mm)	<b>REF 821</b>
			
<b>REF 822</b> (14,4mm)	<b>REF 823</b> (11mm)	<b>REF 823 B</b> (12mm)	<b>REF 824</b> (8,6mm)
			
<b>REF 827</b> (6,8mm)	<b>REF 990</b> (2,3mm)	<b>REF 991</b> (1,5mm)	<b>REF 1035</b>

 <b>REF 1039</b>	 <b>REF 1040 (11,30mm)</b>	 <b>REF 1060</b>	 <b>REF 1138</b>
--	--	--	--























**VEDANTES DE CORRER/"U"**  
**SEALING RODS/"U"**  
**JOINTS DE FENÊTRE/"U"**

























 <b>REF 220</b> (int. 4mm)	 <b>REF 220 F</b> (int. 4mm)	 <b>REF 254</b> (int. 3,3mm)	 <b>REF 254 F</b> (int. 3,3mm)
 <b>REF 260</b> (int. 5,7mm)	 <b>REF 260 K</b> (int. 1,2mm)	 <b>REF 260 KB</b> (int. 1,2mm)	 <b>REF 320</b> (int. 4,7mm)
 <b>REF 320 B</b> (int. 5,7mm)	 <b>REF 366</b> (int. 2,7mm)	 <b>REF 366 A</b> (int. 3mm)	 <b>REF 366 B</b> (int. 4,1mm)
 <b>REF 397</b> (int. 10mm)	 <b>REF 397 B</b> (int. 10mm)	 <b>REF 397 F</b> (int. 10mm)	 <b>REF 397 FF</b> (int. 10mm)
 <b>REF 413</b> (int. 3,8mm)	 <b>REF 423</b> (int. 18mm)	 <b>REF 423 B</b> (int. 20mm)	 <b>REF 423 F</b> (int. 14,5mm)

























 <b>REF 473</b> (int. 4,5mm)	 <b>REF 486</b> (int. 14mm)	 <b>REF 486 B</b> (int. 15mm)	 <b>REF 486 F</b> (int. 12mm)
 <b>REF 489</b> (int. 17mm)	 <b>REF 489 F</b> (int. 17mm)	 <b>REF 490</b> (int. 19mm)	 <b>REF 519</b> (int. 14,5mm)
 <b>REF 519F</b> (int. 18mm)	 <b>REF 531</b> (int. 19mm)	 <b>REF 531 F</b> (int. 18mm)	 <b>REF 538</b> (int. 14,5mm)
 <b>REF 615</b>	 <b>REF 672</b> (int. 1mm)	 <b>REF 746</b> (int. 3,8mm)	 <b>REF 763</b> (int. 3mm)
 <b>REF 869</b> (int. 6mm)	 <b>REF 921</b> (int. 1,3mm)	 <b>REF 951</b> (int. 8mm)	 <b>REF 1023</b> (int. 10mm)
 <b>REF 1118</b> (int. 8mm)			



































**VEDANTES PARA UTILIZAÇÃO DIVERSA**  
SEALANTS FOR SEVERAL USES  
JOINTS DIVERS

 <b>REF 227</b>	 <b>REF 228</b>	 <b>REF 229</b>	 <b>REF 229 A</b>
 <b>REF 229 AB</b>	 <b>REF 229 AF</b>	 <b>REF 230</b>	 <b>REF 231</b>
 <b>REF 232</b>	 <b>REF 233</b>	 <b>REF 236</b>	 <b>REF 238</b>
 <b>REF 239 B</b>	 <b>REF 240</b>	 <b>REF 241</b>	 <b>REF 243</b>
 <b>REF 244</b>	 <b>REF 245</b>	 <b>REF 245 B</b>	 <b>REF 245 BF</b>

 REF 245 BFM	 REF 247	 REF 248	 REF 249
 REF 255	 REF 255 F	 REF 256	 REF 257
 REF 258	 REF 264	 REF 264 B	 REF 264 FB
 REF 269	 REF 269 F	 REF 310	 REF 310 B
 REF 326	 REF 327	 REF 327 A	 REF 327 F
 REF 333	 REF 373	 REF 376	 REF 377



















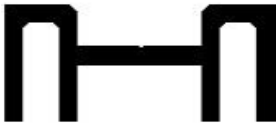



			
REF 385	REF 387	REF 389	REF 395
			
REF 396	REF 398	REF 399	REF 407
			
REF 408	REF 409	REF 411	REF 411 B
			
REF 411 BF	REF M411	REF 412	REF 415
			
REF 416	REF 416 F	REF 416 FF	REF 422
			
REF 424	REF 427	REF 428	REF 431

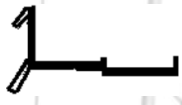



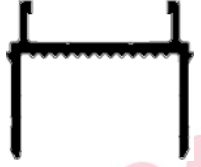

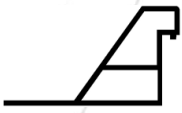

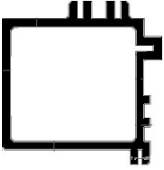

 REF 438	 REF 439	 REF 439 F	 REF 497
 REF 498	 REF 533	 REF 547	 REF 557
 REF 557 B	 REF 579	 REF 580	 REF 584
 REF 586	 REF 600	 REF 606	 REF 617
 REF 626	 REF 627	 REF 628	 REF 632
 REF 647	 REF 650	 REF 682	 REF 695

 REF 740	 REF 760	 REF 909	 REF 976
 REF 979	 REF 987	 REF 1099	 REF 1100
 REF 1102			

## **PERFIS RIJOS PARA CAIXILHARIA DE ALUMÍNIO/PVC**

**RIGID PROFILES FOR ALUMINUM/PVC HOLDER  
PROFILES RIGIDES POUR FENÊTRE D'ALUMINIUM/PVC**

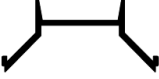
 REF 505	 REF 540	 REF 541	 REF 541 A
 REF 635	 REF 636	 REF 640	 REF 643
 REF 656	 REF 657	 REF 658	 REF 659
 REF 660	 REF 661	 REF 662	 REF 687
 REF 743	 REF 750	 REF 751	 REF 775
 REF 785	 REF 806	 REF 807	 REF 812

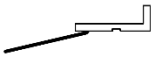



















 <b>REF 813</b>	 <b>REF 814</b>	 <b>REF 838</b>	 <b>REF 981</b>
 <b>REF 1005</b>	 <b>REF 1010</b>	 <b>REF 1041</b>	 <b>REF 1042</b>
 <b>REF 1117</b>	 <b>REF 1119</b>	 <b>REF 1120</b>	 <b>REF 1133</b>











## VEDANTES EM EPDM

EPDM SEALS  
JOINTS EN EPDM























**VEDAÇÃO CENTRAL**  
CENTRAL SEALING  
JOINTS DE FENÊTRE

















 REF EP 40/00	 REF EP 40/16	 REF EP 40/17	 REF EP 40/18
 REF EP 40/19	 REF EP 40/20	 REF EP 40/21	 REF EP 40/22
 REF EP 40/23	 REF EP 40/26	 REF EP 40/27	 REF EP 40/34
 REF EP 40/38	 REF EP 40/41	 REF EP 40/42	 REF EP 40/45
 REF EP 40/48	 REF EP 40/49	 REF EP 40/52	 REF EP 40/53

 REF EP 40/55	 REF EP 40/72	 REF EP 40/73	 REF EP 40/74
 REF EP 41/03	 REF EP 41/04	 REF EP 41/06	 REF EP 41/19
 REF EP 41/50	 REF 41/67	 REF 575	













**BATENTES**  
DOOR STOP SEALS  
JOINTS DE FENÊTRE

 REF EP 40/02	 REF EP 40/09	 REF EP 40/12	 REF EP 40/15
 REF EP 40/24	 REF EP 40/32	 REF EP 40/36	 REF EP 40/37
 REF EP 40/39	 REF EP 40/40	 REF EP 40/46	 REF EP 40/50
 REF EP 40/47	 REF EP 40/51	 REF EP 40/63	 REF EP 40/64
 REF EP 40/66	 REF EP 40/70	 REF EP 40/71	 REF EP 40/75

 REF EP 40/76	 REF EP 40/77	 REF EP 40/78	 REF EP 40/79
 REF EP 40/80	 REF EP 40/95	 REF EP 41/10	 REF EP 41/11
 REF EP 41/21	 REF 41/66	 REF 41/68	 REF EP 556
 REF 574	 REF 705	 REF 738	 REF 779











































**VEDANTES DE CUNHA/APERTO**  
**WEDGE SEALS**  
**JOINTS DE FENÊTRE**









 <b>REF EP 40/43</b>	 <b>REF EP 40/44</b>	 <b>REF EP 40/56</b>	 <b>REF EP 40/69</b>
 <b>REF EP 40/92</b>	 <b>REF EP 40/93</b>	 <b>REF EP 40/94</b>	 <b>REF EP 595</b>
 <b>REF 1062</b>	 <b>REF 1063</b>	 <b>REF 1071</b>	



**VEDANTES DIVERSOS**  
SEALS FOR MULTIPLE USES  
JOINTS DIVERS

 REF EP 40/01	 REF EP 40/03	 REF EP 40/04	 REF EP 40/05
 REF EP 40/06	 REF EP 40/07	 REF EP 40/08	 REF EP 40/10
 REF EP 40/11	 REF EP 40/30	 REF EP 40/33	 REF EP 40/54
 REF EP 40/31			
 REF EP 40/60	 REF EP 40/62	 REF EP 40/96	 REF EP 40/97

















 REF EP 41/00	 REF EP 41/20	 REF 42/20	 REF EP 45/40
 REF EP 45/53	 REF 593	 REF 594	 REF 605
 REF 685	 REF 637	 REF 798	 REF 816
 REF 817	 REF 818	 REF 819	 REF 876
 REF 880	 REF 889	 REF 918	 REF 13
 REF 943	 REF 1036	 REF 1068	 REF 1082

 CORDÃO Ø 3MM	 CORDÃO Ø 3,7MM	 CORDÃO Ø 5,3MM	 CORDÃO Ø 6,5MM
 CORDÃO Ø 8MM	 CORDÃO Ø 10MM	 TIRA 15x10MM	 TIRA 6x7,5MM

## VEDANTES PARA TOLDOS

SEALING PLATES FOR AWNINGS  
JOINTS D'ÉTANCHÉITÉ POUR AUVENTS









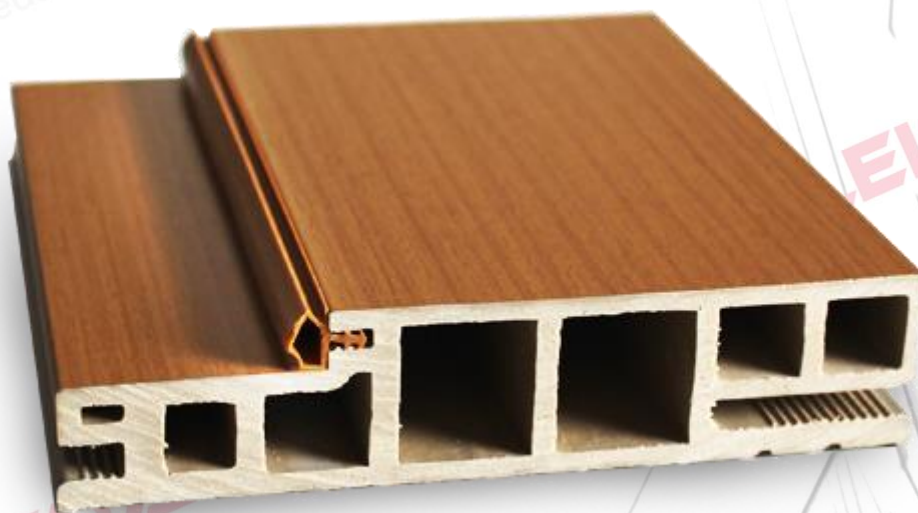

















 <b>C. 6MM Macio (720)</b>	 <b>C. 6MM PVCA</b>	 <b>C. 6MM PE</b>	 <b>C. Solex 5MM (639)</b>
 <b>C. PP 5,5MM (712)</b>	 <b>C. Solex 4,5MM (764)</b>	 <b>C. ABS 1,2MM (910)</b>	 <b>REF 380</b>
 <b>REF 381</b>	 <b>REF 381 F</b>	 <b>REF 382</b>	 <b>REF 382 B</b>
 <b>REF 382 F</b>	 <b>REF 382 FF</b>	 <b>C. PVC 3MM (939)</b>	 <b>REF 448</b>

























## VEDANTES PARA CAIXILHARIA DE MADEIRA







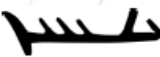

















SEALING PLATES FOR WOOD FURNITURE  
JOINTS POUR APPLICATIONS EN BOIS











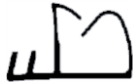









 REF 425	 REF 425 B	 REF 425 F	 REF 459
 REF 459M	 REF 459B	 REF 460	 REF 460 B
 REF 467	 REF 467 B	 REF 467 F	 REF 468
 REF 468 B	 REF 468 F	 REF 499	 REF 500
 REF 500 F	 REF 500 FF	 REF 500 FFF	 REF 500 FFFF
 REF 500 FFFFF	 REF 501	 REF 518	 REF 518 B

 REF 518 F	 REF 520	 REF 525	 REF 525 B
 REF 525 F	 REF 526	 REF 527	 REF 527 B
 REF 539	 REF 544	 REF 544 F	 REF 546
 REF 546 F	 REF 546 FF	 REF 548	 REF 550
 REF 550 B	 REF 550 F	 REF 552	 REF M 552
 REF 558	 REF 558 B	 REF 559	 REF 559 B

























 <b>REF 560</b>	 <b>REF 561</b>	 <b>REF 565</b>	 <b>REF 567</b> (c/ fita bi-adesiva)
 <b>REF 570</b> (c/ fita bi-adesiva)	 <b>REF 571</b> (c/ fita bi-adesiva)	 <b>REF 577</b>	 <b>REF 597</b>
 <b>REF 604</b>	 <b>REF 610</b>	 <b>REF 610 F</b>	 <b>REF 610 FF</b>
 <b>REF 622</b>	 <b>REF 623</b>	 <b>REF 633</b>	 <b>REF 634</b>
 <b>REF 651</b>	 <b>REF 663</b>	 <b>REF 664</b>	 <b>REF 664 B</b>
 <b>REF 664 FB</b>	 <b>REF 665</b>	 <b>REF 666</b>	 <b>REF 666 B</b>





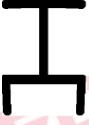



















 REF 666 F	 REF 696	 REF 696 FE	 REF 737
 REF 737 B	 REF 737 F	 REF 739	 REF 747
 REF 755	 REF 758	 REF 765	 REF 769
 REF 770	 REF 795	 REF 796 FF	 REF 797
 REF 828	 REF 850	 REF 851	 REF 892
 REF 930	 REF 935	 REF 936	 REF 937

 REF 938	 REF 942	 REF 948	 REF 949
 REF 969	 REF 970	 REF 978	 REF 984
 REF 997	 REF 998	 REF 1004	 REF 1012
 REF 1013	 REF 1025 (c/ fita bi-adesiva)	 REF 1078	 REF 1092
 REF 1098	 Altura 6, 9, 12 e 16mm PELÚCIA P/ ARO MADEIRA		

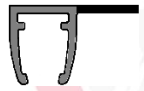
## PERFIS RIJOS PARA VIDRO



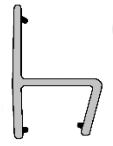





















RIGID PROFILES FOR GLASS  
PROFILS RIGIDES POUR VITRE

























 <b>REF 435</b> (vidro 9mm)	 <b>REF 478</b> (vidro 4mm)	 <b>REF 487</b> (vidro 6mm)	 <b>REF 487 B</b> (vidro 6mm)
 <b>REF 487 F</b> (vidro 6mm)	 <b>REF 487 FF</b> (vidro 6mm)	 <b>REF 495</b> (vidro 6mm)	 <b>REF 545</b> (vidro 10mm)
 <b>REF 549</b> c/fita bi adesiva (double adhesive tape) (vidro 10mm)	 <b>REF 555</b> (vidro 10mm)	 <b>REF 562</b> c/fita bi adesiva (double adhesive tape) (vidro 6mm)	 <b>REF 573</b> (vidro 8mm)
 <b>REF 601</b> (vidro 6mm)	 <b>REF 611</b> (vidro 6mm)	 <b>REF 612</b> (vidro 4mm)	 <b>REF 614</b>
 <b>REF 654</b>	 <b>REF 741</b> c/fita bi adesiva (double adhesive tape) (vidro 6mm)	 <b>REF 757</b> (vidro 5mm)	 <b>REF 757 F</b> (vidro 6mm)
 <b>REF 782</b> (vidro 12mm)	 <b>REF 783</b> (vidro 12mm)	 <b>REF 793</b> c/fita bi adesiva (double adhesive tape) (vidro 8mm)	 <b>REF 811</b>













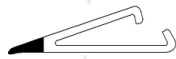









 <b>REF 853</b> (vidro 5mm)	 <b>REF 857</b> (vidro 8mm)	 <b>REF 858</b> (vidro 5mm)	 <b>REF 859</b> (vidro 5mm)
 <b>REF 859 F</b> (vidro 5mm)	 <b>REF 887</b> (vidro 10mm)	 <b>REF 904</b> (vidro 6mm)	 <b>REF 917</b> (vidro 8/10mm)
 <b>REF 923</b> (vidro 6mm)	 <b>REF 924</b> (vidro 4mm)	 <b>REF 928</b> (vidro 4mm)	 <b>REF 961</b> (vidro 4mm)
 <b>REF 962</b> (vidro 10mm)	 <b>REF 982</b> (vidro 8mm)	 <b>REF 1028</b> (vidro 10mm)	 <b>REF 1029</b> (vidro 10mm)
 <b>REF 1033</b> c/fita bi adesiva (double adhesive tape)	 <b>REF 1034</b> (vidro 10mm)	 <b>REF 1056</b> (vidro 6/8mm)	 <b>REF 1072</b> (vidro 8mm)
 <b>REF 1094</b> (vidro 10mm)	 <b>REF 1105</b> c/fita bi adesiva (double adhesive tape) (vidro 12mm)	 <b>REF 1131</b> (vidro 10mm)	 <b>REF 1132</b> (VIDRO 8MM)









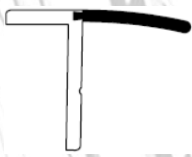















## **VEDANTES E PERFIS PARA APLICAÇÕES ESPECÍFICAS**















**SEALANTS AND PROFILES FOR SPECIFIC APPLICATIONS  
JOINTS ET PROFILS POUR APPLICATIONS SPÉCIFIQUES**

 REF 483	 REF 484	 REF 532	 REF 543
 REF 553	 REF 554	 REF 564	 REF 566
 REF 572	 REF 576	 REF 598	 REF 618
 REF 619	 REF 620	 REF 621	 REF 624
 REF 641	 REF 652	 REF 677	 REF 679
 REF 680	 REF 681	 REF 684	 REF 698

 REF 702	 REF 703	 REF 706	 REF 708
 REF 727	 REF 729	 REF 730	 REF 742
 REF 748	 REF 759	 REF 761	 REF 766
 REF 766 B	 REF 766 F	 REF 768	 REF 772
 REF 773	 REF 774	 REF 794	 REF 808
 REF 830	 REF 831	 REF 835	 REF 836















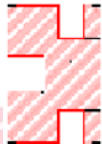
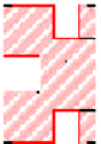
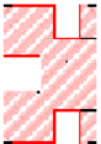



 <b>REF 837</b>	 <b>REF 849</b>	 <b>REF 852</b>	 <b>REF 855</b>
 <b>REF 855 A</b>	 <b>REF 861</b>	 <b>REF 863</b>	 <b>REF 864</b>
 <b>REF 870</b>	 <b>REF 881</b>	 <b>REF 882</b>	 <b>REF 883</b>
 <b>REF 886</b>	 <b>REF 888</b>	 <b>REF 890</b>	 <b>REF 899</b>
 <b>REF 920</b>	 <b>REF 922</b>	 <b>REF 925</b>	 <b>REF 931</b>
 <b>REF 945</b>	 <b>REF 965</b>	 <b>REF 992 (1,9x7,3mm)</b>	 <b>REF 999</b>





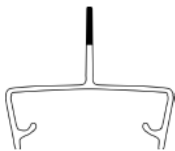
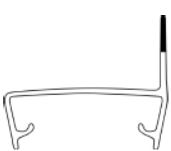

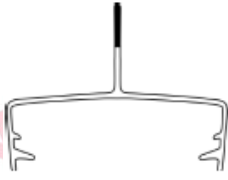

















 <b>REF 1000</b>	 <b>REF 1001</b>	 <b>REF 1002</b>	 <b>REF 1007</b>
 <b>REF 1007F</b>	 <b>REF 1008</b>	 <b>REF 1009</b>	 <b>REF 1011</b>
 <b>REF 1013</b>	 <b>REF 1014</b>	 <b>REF 1016</b>	 <b>REF 1018</b>
 <b>REF 1019</b>	 <b>REF 1020</b>	 <b>REF 1027</b>	 <b>REF 1037</b>
 <b>REF 1045</b>	 <b>REF 1051</b>	 <b>REF 1052</b>	 <b>REF 1053</b>
 <b>REF 1055</b>	 <b>REF 1057</b>	 <b>REF 1058</b>	 <b>REF 1059</b>















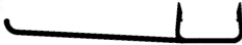

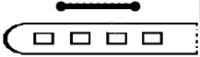
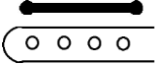





 REF 1061	 REF 1066	 REF 1093	 REF 1096
 REF 1097	 REF 1103	 REF 1107	 REF 1109
 REF 1114	 REF 1116	 REF 1124	 REF 1125 (Ø1,75MM)
 REF 1126	 REF 1128		













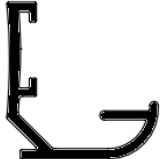

## PERFIS E VEDANTES TÉCNICOS

TECHNICAL PROFILES  
PROFILS ET JOINTS TECHNIQUES

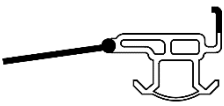
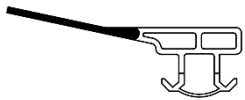
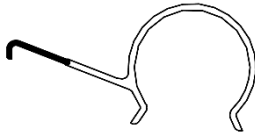
			
<b>REF 551</b>	<b>REF 563</b>	<b>REF 587</b>	<b>REF 592</b>
			
<b>REF 599</b>	<b>REF 599 B</b>	<b>REF 599 F</b>	<b>REF 602</b>
			
<b>REF 603</b>	<b>REF 607</b>	<b>REF 629</b>	<b>REF 630</b>
			
<b>REF 638</b>	<b>REF 655</b>	<b>REF 667</b>	<b>REF 668</b>
			
<b>REF 670</b>	<b>REF 673</b>	<b>REF 675</b>	<b>REF 676</b>
			
<b>REF 678</b>	<b>REF 674</b>	<b>REF 688</b>	<b>REF 709</b>













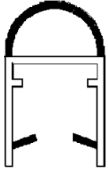
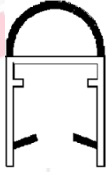





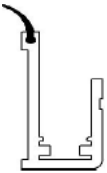



 REF 710	 REF 724	 REF 776	 REF 786
 REF 800	 REF 802	 REF 803	 REF 826
 REF 829	 REF 844	 REF 845	 REF 846
 REF 854	 REF 856	 REF 860	 REF M860
 REF 867	 REF 875	 REF 879	 REF 891
 REF 894	 REF 898	 REF 900	 REF 902







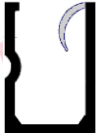

















 <b>REF 914</b>	 <b>REF 915</b>	 <b>REF 926</b>	 <b>REF 927</b>
 <b>REF 947</b>	 <b>REF 953</b>	 <b>REF 954</b>	 <b>REF 956</b>
 <b>REF 957</b>	 <b>REF 968</b>	 <b>REF 971</b>	 <b>REF 973</b>
 <b>REF 974</b>	 <b>REF 980</b>	 <b>REF 983</b>	 <b>REF 1006</b>
 <b>REF 1015</b>	 <b>REF 1024</b>	 <b>REF 1030</b>	 <b>REF 1031</b>
 <b>REF 1032</b>	 <b>REF 1043</b>	 <b>REF 1046</b>	 <b>REF 1047</b>

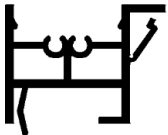



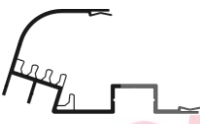









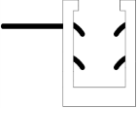

			
<b>REF 1064</b>	<b>REF 1074</b>	<b>REF 1079</b>	<b>REF 1080</b>
			
<b>REF 1081</b>	<b>REF 1090</b>	<b>REF 1095</b>	<b>REF 1134</b>
			
<b>REF 1086</b>	<b>REF 1087</b>	<b>REF 1088</b>	<b>REF 1101</b>
			
<b>REF 1108</b>	<b>REF 1111</b>	<b>REF 1112</b>	<b>REF 1121</b>
			
<b>REF 1122</b>			

## **INDÚSTRIA DE FRIO E MÁQUINAS INDUSTRIAIS**

**COLD INDUSTRY AND INDUSTRIAL MACHINERY  
INDUSTRIE FROIDE ET MACHINES INDUSTRIELLES**

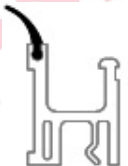

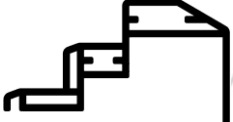













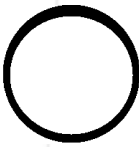
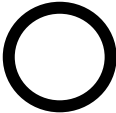

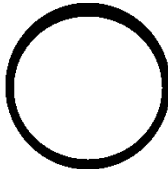
			
REF 481	REF 491	REF 529	REF 529 F
			
REF 569	REF 596	REF 609	REF 616
			
REF 631	REF 642	REF 644	REF 645
			
REF 646	REF 669	REF 671	REF 691
			
REF 692	REF 697 A	REF 697 B	REF 697 C
			
REF 699	REF 725	REF ~728	REF ~731

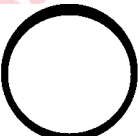
			
REF 732	REF 733	REF 744	REF 745
			
REF 753	REF 754	REF 762	REF 767
			
REF 780	REF 781	REF 784	REF 792
			
REF ~804	REF ~810	REF 842	REF 847
			
REF 865	REF 866	REF ~868	REF 895
			
REF ~897	REF 901	REF 903	REF ~905

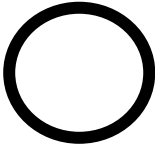
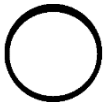
 REF 908	 REF 911	 REF 912	 REF 946
 REF 950	 REF 1003	 REF 1022	 REF 1048
 REF 1050	 REF 1054	 REF 1065	 REF 1083
 REF 1084	 REF 1089	 REF ~1106	 REF 1113
 REF 1135	 REF 1137		

## ILUMINAÇÃO INDUSTRIAL



INDUSTRIAL LIGHTENING  
ÉCLAIRAGE INDUSTRIEL

 <b>REF 832</b>	 <b>REF 833</b>	 <b>REF 839</b>	 <b>REF 840</b>
 <b>REF 841</b>	 <b>REF 843</b>	 <b>REF 873</b>	 <b>REF 1017 (24x30mm)</b>
 <b>REF 1026 (26x28mm)</b>	 <b>REF 1044 (24x26mm)</b>	 <b>REF 1067</b>	 <b>REF 1069</b>
 <b>REF 1070</b>	 <b>REF 1073</b>	 <b>REF 1075</b>	 <b>REF 1076</b>
 <b>REF 1077</b>	 <b>REF 1085</b>	 <b>REF 1104</b>	 <b>REF 1110</b>
 <b>REF 1115</b>	 <b>REF 1127</b>	 <b>REF 1129</b>	 <b>REF 1130</b>

## PRODUTOS DE INJEÇÃO

INJECTION AREA

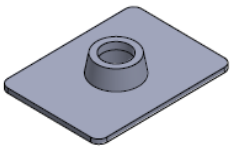
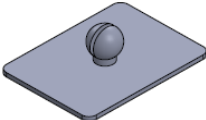
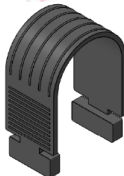
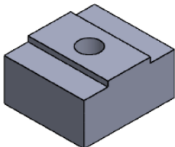
PRODUITS D'INJECTION

 <b>REF 952</b>	 <b>REF 957</b>	 <b>REF 959</b>	 <b>REF 988</b>
 <b>REF 989</b>	 <b>REF 1021</b>		

RAL 1000	RAL 1011	RAL 1019	RAL 1033	RAL 2009	RAL 3004	RAL 3015
RAL 1001	RAL 1012	RAL 1020	RAL 1034	RAL 2010	RAL 3005	RAL 3016
RAL 1002	RAL 1013	RAL 1021	RAL 2000	RAL 2011	RAL 3007	RAL 3017
RAL 1003	RAL 1014	RAL 1023	RAL 2001	RAL 2012	RAL 3009	RAL 3018
RAL 1004	RAL 1015	RAL 1024	RAL 2002	RAL 3000	RAL 3011	RAL 3020
RAL 1005	RAL 1016	RAL 1027	RAL 2003	RAL 3001	RAL 3012	RAL 3022
RAL 1006	RAL 1017	RAL 1028	RAL 2004	RAL 3002	RAL 3013	RAL 3027
RAL 1007	RAL 1018	RAL 1032	RAL 2008	RAL 3003	RAL 3014	RAL 3031

RAL 4001	RAL 4009	RAL 5008	RAL 5017	RAL 6000	RAL 6008	RAL 6016
RAL 4002	RAL 5000	RAL 5009	RAL 5018	RAL 6001	RAL 6009	RAL 6017
RAL 4003	RAL 5001	RAL 5010	RAL 5019	RAL 6002	RAL 6010	RAL 6018
RAL 4004	RAL 5002	RAL 5011	RAL 5020	RAL 6003	RAL 6011	RAL 6019
RAL 4005	RAL 5003	RAL 5012	RAL 5021	RAL 6004	RAL 6012	RAL 6020
RAL 4006	RAL 5004	RAL 5013	RAL 5022	RAL 6005	RAL 6013	RAL 6021
RAL 4007	RAL 5005	RAL 5014	RAL 5023	RAL 6006	RAL 6014	RAL 6022
RAL 4008	RAL 5007	RAL 5015	RAL 5024	RAL 6007	RAL 6015	RAL 6024

RAL 6025	RAL 7000	RAL 7009	RAL 7022	RAL 7034	RAL 7043	RAL 8008
RAL 6026	RAL 7001	RAL 7010	RAL 7023	RAL 7035	RAL 7044	RAL 8011
RAL 6027	RAL 7002	RAL 7011	RAL 7024	RAL 7036	RAL 8000	RAL 8012
RAL 6028	RAL 7003	RAL 7012	RAL 7026	RAL 7037	RAL 8001	RAL 8014
RAL 6029	RAL 7004	RAL 7013	RAL 7030	RAL 7038	RAL 8002	RAL 8015
RAL 6032	RAL 7005	RAL 7015	RAL 7031	RAL 7039	RAL 8003	RAL 8016
RAL 6033	RAL 7006	RAL 7016	RAL 7032	RAL 7040	RAL 8004	RAL 8017
RAL 6034	RAL 7008	RAL 7021	RAL 7033	RAL 7042	RAL 8007	RAL 8019

RAL 8022	RAL 8028	RAL 9003	RAL 9011
RAL 8023	RAL 9000	RAL 9004	RAL 9016
RAL 8024	RAL 9001	RAL 9005	RAL 9017
RAL 8025	RAL 9002	RAL 9010	RAL 9018

 +351 244 616 210

 [commercial@leirivedante.pt](mailto:commercial@leirivedante.pt)  
[geral@leirivedante.pt](mailto:geral@leirivedante.pt)

 +351 963 424 018



 Scan me