

CATÁLOGO DE PRODUTOS

PRODUCTS CATALOG
CATALOGUE DE PRODUITS

2025

Vedantes para Caixilharia de Alumínio/PVC	4
Sealants for Aluminium/PVC Holder	
Joints pour Fenêtre d'Aluminium/PVC	
Perfis de Duas Durezas	5
Two Hardness Profiles	
Profils de Deux Duretés	
Vedação Central	8
Central Sealing	
Joints de Fenêtre	
Batentes	10
Door Stop Seals	
Joints de Fenêtre	
Vedantes de Cunha/Aperto	13
Wedge Seals	
Joints de Fenêtre	
Vedantes de Correr/ »U »	18
Sealing Rods/»U»	
Joints de Fenêtre/»U»	
Vedantes para Divisórias	20
Sealing Plates	
Joints de Cloison	
Vedantes para Utilização Diversa	23
Sealants for several uses	
Joints Divers	
Vedantes em EPDM	25
EPDM Seals	
Joints en EPDM	
Vedação Central	26
Central Sealing	
Joints de Fenêtre	
Batentes	28
Door Stop Seals	
Joints de Fenêtre	
Vedantes de Cunha/Aperto	31
Wedge Seals	
Joints de Fenêtre	
Vedantes Diversos	32
Seals for Multiple Uses	
Joints Divers	
Vedantes para Toldos	34
Sealing Plates for Awning	
Joints D'Étanchéité pour Auvents	
Vedantes para Caixilharia de Madeira	36
Sealing Plates for Wood Furniture	
Joints pour Applications en Bois	
Perfis Rijos Para Vidro	42
Rigid Profiles for Glass	
Profils Rifides pour Vitre	
Vedantes e Perfis para Aplicações Específicas	45
Sealants and Profiles for Specific Applications	
Joints et Profils pour Applications Spécifiques	
Perfis e Vedantes Técnicos	53
Technical Profiles	
Profils Techniques	
Indústria de Frio e Máquinas Industriais	59
Cold Industry and Industrial Machinery	
Industrie Froide et Machines Industrielles	
Projetos de Injeção	63
Injection Area	
Projects d'Injection	

Observações:

- ☑ As encomendas consideradas *standard* poderão ser entregues em 3 dias após o seu pedido;
- ☑ Todos os produtos do catálogo poderão ser fabricados na cor mais conveniente para o cliente;
- ☑ Os nossos produtos estão sujeitos a quantidades mínimas de encomenda, variando as mesmas por referência e por cor;
- ☑ Neste catálogo não está representado todo o nosso portfolio de produtos. Para mais informações sobre os mesmos, ou para esclarecimentos sobre a possibilidade de produção de outros perfis, por favor, contate o nosso departamento comercial;
- ☑ Alguns dos produtos aqui apresentados são abrangidos pela nossa cláusula de exclusividade.

Comments:

- ☑ Orders considered *standard* can be delivered within 3 days after your order, in Portugal;
- ☑ All products from this catalog can be manufactured in the most convenient color for the customer;
- ☑ Our products are subject to minimum order quantities, varying by reference and color;
- ☑ This catalog does not represent our entire product portfolio. For more information about them, or for clarification about the possibility of producing other profiles, please contact our commercial department;
- ☑ Some of the products presented here are covered by our exclusivity clause.

Notes:

- ☑ Les commandes considérées comme *standard* peuvent être expédié dans les 3 jours suivant à votre commande, au Portugal ;
- ☑ Tous les produits du catalogue peuvent être fabriqués dans la couleur la plus convenue pour le client;
- ☑ Nos produits ont des quantités minimum de commande, variant par référence et par couleur;
- ☑ Ce catalogue ne représente pas l'ensemble de notre portefeuille de produits. Pour plus d'informations à leur sujet ou pour obtenir des précisions sur la possibilité de produire d'autres profils, veuillez contacter notre service commercial.
- ☑ Certains produits présentés ici sont couverts par notre clause d'exclusivité.

VEDANTES PARA CAIXILHARIA DE ALUMÍNIO/PVC





















SEALANTS FOR ALUMINUM/PVC HOLDER
JOINTS POUR FENÊTRE D'ALUMINIUM/PVC











































PERFIS DE DUAS DUREZAS
TWO HARDNESS PROFILES
PROFILS DE DEUX DURETÉS

NOTA: Os perfis de duas durezas estão disponíveis com bases de diversas medidas
NOTE: The profiles of two hardnesses are available with various base measures
NOTE: Les profils de deux duretés sont disponibles avec des bases de différentes mesures





















 REF 456	 REF 456 F	 REF 456 FF	 REF 456 FFF
 REF 456FB	 REF 457	 REF 458	 REF 479
 REF 479 B	 REF 479 F	 REF 480	 REF 488
 REF 504	 REF M504	 REF 506	 REF 506 B
 REF 506 F	 REF 506 FF	 REF 507	 REF 507 B

 REF 507 F	 REF M507	 REF 508	 REF 508 F
 REF 508 FF	 REF 511	 REF M511	 REF 512
 REF 513	 REF 513 B	 REF 513 BF	 REF 513 F
 REF 514	 REF 515	 REF 515 B	 REF 515 F
 REF 516	 REF 516 F	 REF 516 FB	 REF 521
 REF 522	 REF 522 F	 REF 523	 REF 534

 REF 536	 REF 542	 REF 548	 REF 578
 REF 582	 REF 583	 REF 688	 REF 756
 REF 771	 REF 893	 REF 916	 REF 929
 REF 944	 REF 1038	 REF 1091	







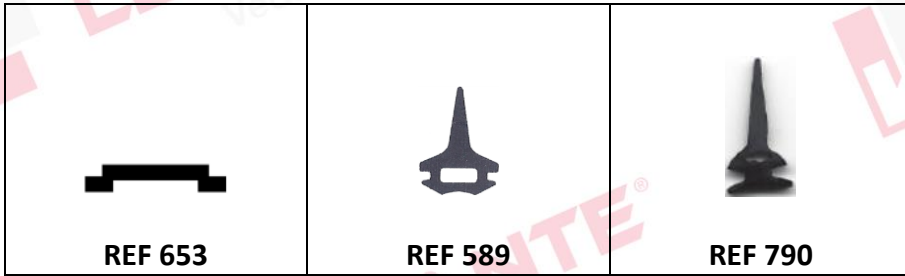















VEDAÇÃO CENTRAL
CENTRAL SEALING
JOINTS DE FENÊTRE

























 REF 417	 REF 417 F	 REF 417 FF	 REF 447
 REF 447 F	 REF 453	 REF 453 TPS	 REF 462
 REF 462 TPS	 REF 462 F	 REF 465	 REF 465 F
 REF 502	 REF 502 B	 REF 502 F	 REF 502 FF
 REF 524	 REF 528	 REF 530	 REF 535



















BATENTES
DOOR STOP SEALS
JOINTS DE FENÊTRE





















 REF 225	 REF 225 B	 REF 225 CA	 REF 242
 REF 246	 REF 246 B	 REF 250	 REF 256
 REF 259	 REF 265	 REF 265 B	 REF 265 F
 REF 265 FB	 REF 266	 REF 268	 REF 268 F
 REF 268 FF	 REF 325	 REF 328	 REF 328 A

























 REF 328 F	 REF 360	 REF 375	 REF 375 B
 REF 378	 REF 386	 REF 388	 REF 390
 REF 391	 REF 392	 REF 394	 REF 400
 REF 401	 REF 418	 REF 420	 REF 426
 REF 426 B	 REF 426 F	 REF 426 FF	 REF 440
 REF 449	 REF 450	 REF 450 B	 REF 450 F

























 REF 463	 REF 463 F	 REF 463 TPS	 REF 464
 REF 464 F	 REF 464 TPS	 REF 517	 REF 517 B
 REF 517 F	 REF 517 FF	 REF 588	 REF 590
 REF 591	 REF 608		































VEDANTES DE CUNHA/APERTO
WEDGE SEALS
JOINTS DE FENÊTRE

 REF 223	 REF 223 B	 REF 223 BF	 REF 223 BFM
 REF 223 BFM+	 REF 223 F	 REF 223 FF	 REF 223 FFF
 REF 223 FFFF	 REF 223 FFFFF	 REF 223 FB	 REF 226
 REF 234	 REF 234 B	 REF 235	 REF 235 B
 REF 235 BF	 REF 235 BFM	 REF 251	 REF 252

 REF 314	 REF 314 B	 REF 314 BF	 REF 314 BFM
 REF 314 F	 REF 314 FF	 REF 315	 REF 315 B
 REF 315 F	 REF 315 FF	 REF 315 FFF	 REF 316
 REF 316 B	 REF 316 BF	 REF 316 F	 REF 316 FF
 REF 323	 REF 393	 REF 402	 REF 403
 REF 404	 REF 405	 REF 406	 REF 406 B





















			
REF 406 BF	REF 410	REF 410 F	REF 410 FBB
			
REF 429	REF 429 B	REF 429 F	REF 432
			
REF M432	REF 432 F	REF 432 FF	REF 437
			
REF 452	REF 469	REF 469 B	REF 469 F
			
REF 469 F+	REF 470	REF 470 B	REF 470 F
			
REF 470 FB	REF 471	REF 474	REF 475



















			
REF 476	REF 482	REF 509	REF 509 B
			
REF 509 F	REF 509 TPS	REF 537	REF 581
			
REF 581 B	REF 581 F	REF 581 FF	REF 585
			
REF M585	REF 613	REF 613 F	REF 820
			
REF 821	REF 822	REF 823	REF 823 B
			
REF 824	REF 827	REF 990	REF 991

 REF 1035	 REF 1039	 REF 1040	 REF 1060
--	--	--	--























VEDANTES DE CORRER/"U"
SEALING RODS/"U"
JOINTS DE FENÊTRE/"U"

























 REF 220	 REF 220 F	 REF 254	 REF 254 F
 REF 260	 REF 260 K	 REF 260 KB	 REF 320
 REF 320 B	 REF 366	 REF 366 A	 REF 366 B
 REF 397	 REF 397 B	 REF 397 F	 REF 397 FF
 REF 413	 REF 423	 REF 423 B	 REF 423 F



 REF 473	 REF 486	 REF 486 B	 REF 486 F
 REF 489	 REF 489 F	 REF 490	 REF 519
 REF 519F	 REF 531	 REF 531 F	 REF 538
 REF 672	 REF 746	 REF 763	 REF 869
 REF 921	 REF 951	 REF 1023	



VEDANTES PARA DIVISÓRIAS
SEALING PLATES
JOINTS DE CLOISON



















 REF 227	 REF 228	 REF 229	 REF 229 A
 REF 229 AB	 REF 229 AF	 REF 230	 REF 232
 REF 233	 REF 236	 REF 238	 REF 239 B
 REF 240	 REF 244	 REF 245	 REF 245 B
 REF 245 BF	 REF 245 BFM	 REF 247	 REF 248

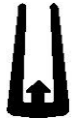















 REF 249	 REF 256	 REF 257	 REF 258
 REF 262	 REF 264	 REF 264 B	 REF 264 FB
 REF 326	 REF 327	 REF 327 A	 REF 327 F
 REF 385	 REF 389	 REF 395	 REF 396
 REF 398	 REF 408	 REF 409	 REF 411
 REF 411 B	 REF 411 BF	 REF M411	 REF 412

 REF 422	 REF 498	 REF 987
---	---	---



VEDANTES PARA UTILIZAÇÃO DIVERSA
SEALANTS FOR SEVERAL USES
JOINTS DIVERS

 REF 231	 REF 243	 REF 255	 REF 255 F
 REF 269	 REF 269 F	 REF 310	 REF 310 B
 REF 376	 REF 377	 REF 387	 REF 399
 REF 407	 REF 415	 REF 416	 REF 416 F
 REF 416 FF	 REF 424	 REF 427	 REF 428





















 REF 431	 REF 439	 REF 439 F	 REF 492
 REF 547	 REF 617	 REF 627	 REF 628
 REF 632	 REF 650	 REF 647	 REF 682
 REF 740	 REF 760	 REF 976	 REF 979
 REF 1102			











VEDANTES EM EPDM

EPDM SEALS
JOINTS EN EPDM













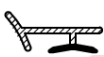







VEDAÇÃO CENTRAL
CENTRAL SEALING
JOINTS DE FENÊTRE

























 REF EP 40/00	 REF EP 40/16	 REF EP 40/17	 REF EP 40/18
 REF EP 40/19	 REF EP 40/20	 REF EP 40/21	 REF EP 40/22
 REF EP 40/23	 REF EP 40/26	 REF EP 40/27	 REF EP 40/34
 REF EP 40/38	 REF EP 40/41	 REF EP 40/42	 REF EP 40/45
 REF EP 40/48	 REF EP 40/49	 REF EP 40/52	 REF EP 40/53

















			
REF EP 40/55	REF EP 40/72	REF EP 40/73	REF EP 40/74
			
REF EP 41/03	REF EP 41/04	REF EP 41/06	REF EP 41/19
			
REF EP 41/50	REF 41/67	REF 575	



BATENTES
DOOR STOP SEALS
JOINTS DE FENÊTRE













 REF EP 001	 REF DDEP 002	 REF DDEP 003	 REF DDEP 007
 REF DDEP 008	 REF DDEP 016	 REF DDEP 01/7-9	 REF DDEP 02/5-7
 REF DDEP 03/4-6	 REF DDEP 04/5,8-9,2	 REF DDEP 06/5,7	 REF DDEP 07/5-7
 REF DDEP 08/5-9,2	 REF DDEP 10/5,5-7	 REF DDEP 11/7,5-9	 REF DDEP 12/7-9,2
 REF DDEP 14/5-7	 REF DDEP 15/4-5	 REF DDEP 16/4-6	 REF DDEP 17/7-9

 REF DDEP 21	 REF EP 40/02	 REF EP 40/09	 REF EP 40/12
 REF EP 40/15	 REF EP 40/24	 REF EP 40/28	 REF EP 40/29
 REF EP 40/32	 REF DDEP 40/35	 REF EP 40/36	 REF EP 40/37
 REF EP 40/39	 REF EP 40/40	 REF EP 40/46	 REF EP 40/50
 REF EP 40/47	 REF EP 40/51	 REF EP 40/63	 REF EP 40/64
 REF EP 40/66	 REF EP 40/70	 REF EP 40/71	 REF EP 40/75

 REF EP 40/76	 REF EP 40/77	 REF EP 40/78	 REF EP 40/79
 REF EP 40/80	 REF EP 40/95	 REF EP 41/10	 REF EP 41/11
 REF EP 41/21	 REF 41/66	 REF 41/68	 REF EP 556
 REF 574	 REF 705	 REF 738	 REF 779











































VEDANTES DE CUNHA/APERTO
WEDGE SEALS
JOINTS DE FENÊTRE

 REF EP 40/43	 REF EP 40/44	 REF EP 40/56	 REF EP 40/69
 REF EP 40/92	 REF EP 40/93	 REF EP 40/94	 REF EP 595
 REF 1062	 REF 1063	 REF 1071	 REF 1082



VEDANTES DIVERSOS
SEALS FOR MULTIPLE USES
JOINTS DIVERS

















 REF EP 40/01	 REF EP 40/03	 REF EP 40/04	 REF EP 40/05
 REF EP 40/06	 REF EP 40/07	 REF EP 40/08	 REF EP 40/10
 REF EP 40/11	 REF EP 40/30	 REF EP 40/33	 REF EP 40/54
 REF EP 40/31			
 REF EP 40/60	 REF EP 40/62	 REF EP 40/96	 REF EP 40/97

 REF EP 41/00	 REF EP 41/20	 REF 42/20	 REF EP 45/40
 REF EP 45/53	 REF 593	 REF 594	 REF 605
 REF 685	 REF 637	 REF 798	 REF 816
 REF 817	 REF 818	 REF 819	 REF 876
 REF 880	 REF 889	 REF 918	 REF 13
 15x10MM	 REF 943	 REF 1036	 REF 1068

VEDANTES PARA TOLDOS

SEALING PLATES FOR AWNINGS
JOINTS D'ÉTANCHÉITÉ POUR AUVENTS









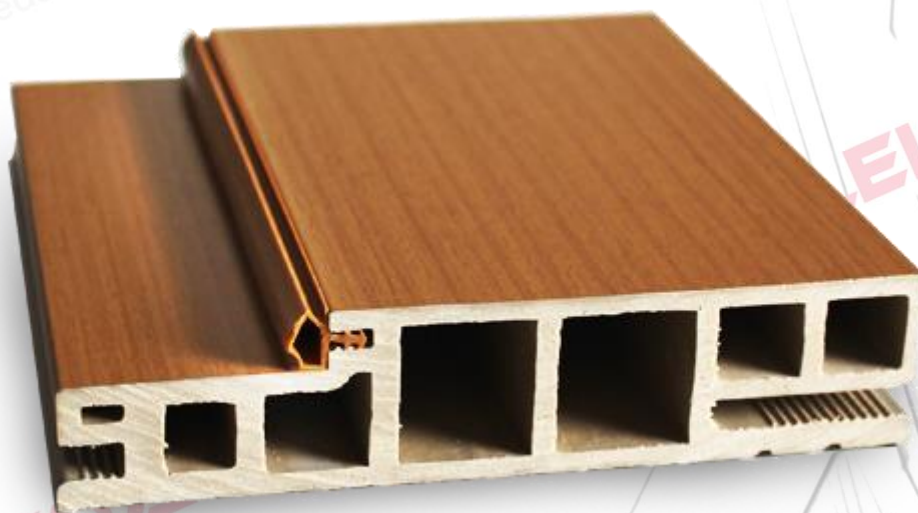

















 C. 6MM Macio (720)	 C. 6MM PVCA	 C. 6MM PE	 REF 380
 REF 381	 REF 381 F	 REF 382	 REF 382 B
 REF 382 F	 REF 382 FF	 C. PVC 3MM (939)	 REF 448
 C. Solex 5MM (639)	 C. PP 5,5MM (712)	 C. Solex 4,5MM (764)	 C. ABS 1,2MM (910)

























VEDANTES PARA CAIXILHARIA DE MADEIRA

























SEALING PLATES FOR WOOD FURNITURE
JOINTS POUR APPLICATIONS EN BOIS











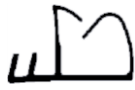

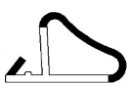







 REF 425	 REF 425 B	 REF 425 F	 REF 459
 REF 459M	 REF 459B	 REF 460	 REF 460 B
 REF 467	 REF 467 B	 REF 467 F	 REF 468
 REF 468 B	 REF 468 F	 REF 499	 REF 500
 REF 500 F	 REF 500 FF	 REF 500 FFF	 REF 500 FFFF
 REF 500 FFFFF	 REF 501	 REF 518	 REF 518 B

 REF 518 F	 REF 520	 REF 525	 REF 525 B
 REF 525 F	 REF 526	 REF 527	 REF 527 B
 REF 539	 REF 544	 REF 544 F	 REF 546
 REF 546 F	 REF 546 FF	 REF 548	 REF 550
 REF 550 B	 REF 550 F	 REF 552	 REF M 552
 REF 558	 REF 558 B	 REF 559	 REF 559 B























 REF 560	 REF 561	 REF 565	 REF 567 (c/ fita bi-adesiva)
 REF 570 (c/ fita bi-adesiva)	 REF 571 (c/ fita bi-adesiva)	 REF 577	 REF 597
 REF 604	 REF 610	 REF 610 F	 REF 610 FF
 REF 622	 REF 623	 REF 633	 REF 634
 REF 651	 REF 663	 REF 664	 REF 664 B
 REF 664 FB	 REF 665	 REF 666	 REF 666 B







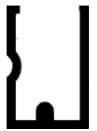
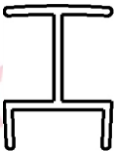
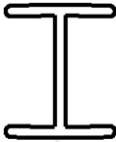









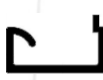





 REF 666 F	 REF 696	 REF 696 FE	 REF 737
 REF 737 B	 REF 737 F	 REF 739	 REF 747
 REF 755	 REF 758	 REF 765	 REF 769
 REF 770	 REF 795	 REF 796 FF	 REF 797
 REF 828	 REF 850	 REF 851	 REF 892
 REF 930	 REF 935	 REF 936	 REF 937

 REF 938	 REF 942	 REF 948	 REF 949
 REF 969	 REF 970	 REF 978	 REF 984
 REF 997	 REF 998	 REF 1004	 REF 1012
 REF 1013	 REF 1025 (c/ fita bi-adesiva)	 REF 1078	 REF 1092
 REF 1098	 Altura 6, 9, 12 e 16mm PELÚCIA P/ ARO MADEIRA		

PERFIS RIJOS PARA VIDRO















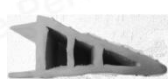

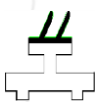





RIGID PROFILES FOR GLASS
PROFILS RIGIDES POUR VITRE



















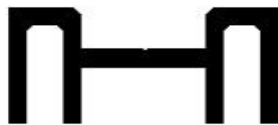





 REF 435	 REF 478	 REF 487	 REF 487 B
 REF 487 F	 REF 487 FF	 REF 545	 REF 549
 REF 555	 REF 562	 REF 568	 REF 573
 REF 601	 REF 611	 REF 612	 REF 614
 REF 654	 REF 741	 REF 757	 REF 757 F
 REF 781	 REF 782	 REF 783	 REF 793

























 REF 811	 REF 853	 REF 857	 REF 858
 REF 859	 REF 859 F	 REF 887	 REF 904
 REF 917	 REF 923	 REF 924	 REF 928
 REF 961	 REF 962	 REF 982	 REF 1028
 REF 1029	 REF 1033	 REF 1034	 REF 1056
 REF 1072	 REF 1094	 REF 1105	















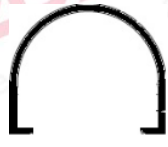







VEDANTES E PERFIS PARA APLICAÇÕES ESPECÍFICAS



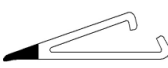

















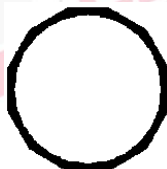

SEALANTS AND PROFILES FOR SPECIFIC APPLICATIONS
JOINTS ET PROFILS POUR APPLICATIONS SPÉCIFIQUES

















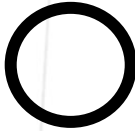





 REF 241	 REF 333	 REF 373	 REF 438
 REF 483	 REF 497	 REF 505	 REF 532
 REF 541	 REF 541 A	 REF 557	 REF 557 B
 REF 572	 REF 579	 REF 580	 REF 584
 REF 586	 REF 598	 REF 600	 REF 606
 REF 615	 REF 618	 REF 619	 REF 620











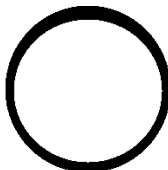
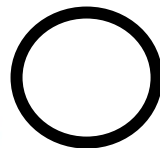
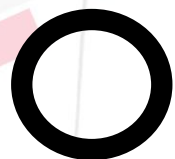
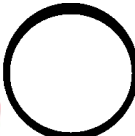

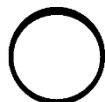
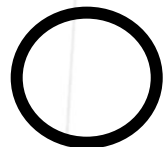

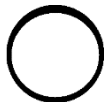
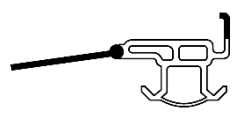
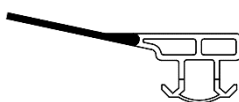
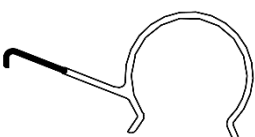

 REF 621	 REF 624	 REF 626	 REF 635
 REF 636	 REF 640	 REF 641	 REF 652
 REF 656	 REF 657	 REF 658	 REF 659
 REF 660	 REF 661	 REF 662	 REF 677
 REF 679	 REF 680	 REF 681	 REF 684
 REF 695	 REF 698	 REF 702	 REF 703

 REF 706	 REF 708	 REF 727	 REF 729
 REF 730	 REF 742	 REF 743	 REF 748
 REF 750	 REF 751	 REF 753	 REF 759
 REF 761	 REF 766	 REF 766 B	 REF 766 F
 REF 768	 REF 772	 REF 773	 REF 774
 REF 775	 REF 784	 REF 794	 REF 801

 REF 805	 REF 808	 REF 830	 REF 831
 REF 832	 REF 833	 REF 835	 REF 836
 REF 837	 REF 838	 REF 839	 REF 840
 REF 841	 REF 842	 REF 843	 REF 849
 REF 852	 REF 855	 REF 855 A	 REF 861
 REF 863	 REF 864	 REF 870	 REF 873





















 REF 881	 REF 882	 REF 883	 REF 886
 REF 888	 REF 890	 REF 899	 REF 908
 REF 909	 REF 920	 REF 922	 REF 925
 REF 931	 REF 945	 REF 992	 REF 999
 REF 1000	 REF 1001	 REF 1002	 REF 1006
 REF 1007	 REF 1007F	 REF 1008	 REF 1009



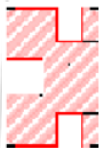
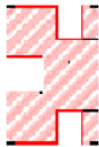
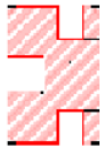









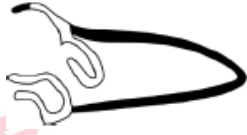

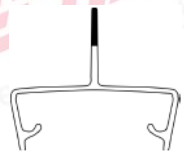
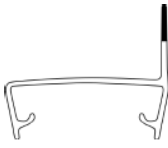

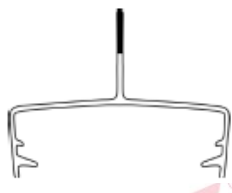



 REF 1011	 REF 1013	 REF 1014	 REF 1018
 REF 1016	 REF 1019	 REF 1020	 REF 1026
 REF 1027	 REF 1037	 REF 1044	 REF 1045
 REF 1048	 REF 1050	 REF 1051	 REF 1052
 REF 1053	 REF 1054	 REF 1055	 REF 1057
 REF 1058	 REF 1059	 REF 1061	 REF 1065

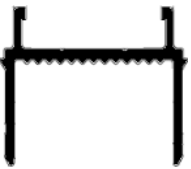





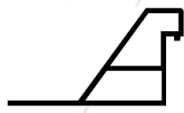



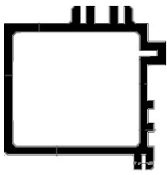











 REF 1066	 REF 1067	 REF 1069	 REF 1070
 REF 1073	 REF 1075	 REF 1076	 REF 1077
 REF 1083	 REF 1085	 REF 1086	 REF 1087
 REF 1088	 REF 1093	 REF 1096	 REF 1097
 REF 1099	 REF 1100	 REF 1101	 REF 1103
 REF 1104	 REF 1107	 REF 1108	 REF 1109











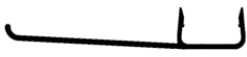









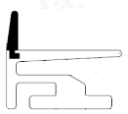

PERFIS E VEDANTES TÉCNICOS





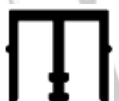

TECHNICAL PROFILES
PROFILS ET JOINTS TECHNIQUES

			
REF 472	REF 484	REF 496	REF 533
			
REF 540	REF 543	REF 551	REF 553
			
REF 554	REF 563	REF 564	REF 566
			
REF 576	REF 587	REF 592	REF 599
			
REF 599 B	REF 599 F	REF 602	REF 603
			
REF 607	REF 629	REF 630	REF 638

 REF 643	 REF 655	 REF 667	 REF 668
 REF 670	 REF 673	 REF 675	 REF 676
 REF 678	 REF 674	 REF 688	 REF 687
 REF 709	 REF 710	 REF 724	 REF 776
 REF 785	 REF 786	 REF 800	 REF 802
 REF 803	 REF 806	 REF 807	 REF 812



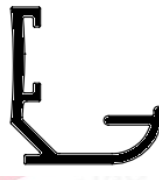









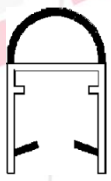
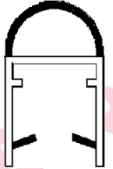

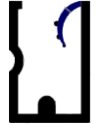

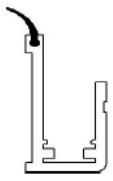



 REF 813	 REF 814	 REF 826	 REF 829
 REF 844	 REF 845	 REF 846	 REF 854
 REF 856	 REF 860	 REF M860	 REF 867
 REF 875	 REF 879	 REF 891	 REF 894
 REF 898	 REF 900	 REF 902	 REF 914
 REF 915	 REF 926	 REF 927	 REF 947







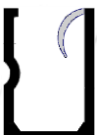













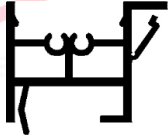

 REF 953	 REF 954	 REF 956	 REF 957
 REF 965	 REF 968	 REF 971	 REF 973
 REF 974	 REF 980	 REF 981	 REF 983
 REF 1005	 REF 1010	 REF 1015	 REF 1024
 REF 1030	 REF 1031	 REF 1032	 REF 1041
 REF 1042	 REF 1043	 REF 1046	 REF 1047



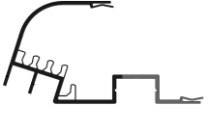



 REF 1064	 REF 1074	 REF 1079	 REF 1080
 REF 1081	 REF 1090	 REF 1095	

INDÚSTRIA DE FRIO E MÁQUINAS INDUSTRIAIS

COLD INDUSTRY AND INDUSTRIAL MACHINERY
INDUSTRIE FROIDE ET MACHINES INDUSTRIELLES

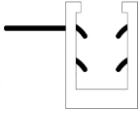
 REF 481	 REF 491	 REF 495	 REF 529
 REF 529 F	 REF 569	 REF 596	 REF 609
 REF 616	 REF 631	 REF 642	 REF 644
 REF 645	 REF 646	 REF 669	 REF 671
 REF 691	 REF 692	 REF 697 A	 REF 697 B
 REF 697 C	 REF 699	 REF 725	 REF ~728

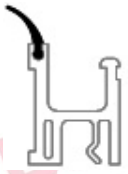

 REF ~731	 REF 732	 REF 733	 REF 744
 REF 745	 REF 754	 REF 762	 REF 767
 REF 780	 REF 792	 REF ~804	 REF ~810
 REF 847	 REF 865	 REF 866	 REF ~868
 REF 895	 REF ~897	 REF 901	 REF 903
 REF ~905	 REF 911	 REF 912	 REF 946

 REF 946	 REF 950	 REF 1003	 REF 1084
 REF 1089	 REF ~1106		

PROJETOS DE INJEÇÃO

INJECTION AREA

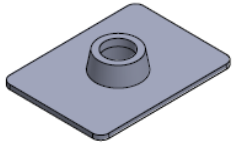
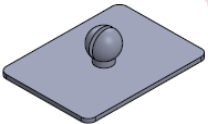
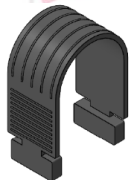
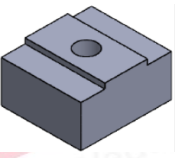
PROJETS D'INJECTION

 REF 952	 REF 957	 REF 959	 REF 988
 REF 989	 REF 1021		

RAL 1000	RAL 1011	RAL 1019	RAL 1033	RAL 2009	RAL 3004	RAL 3015
RAL 1001	RAL 1012	RAL 1020	RAL 1034	RAL 2010	RAL 3005	RAL 3016
RAL 1002	RAL 1013	RAL 1021	RAL 2000	RAL 2011	RAL 3007	RAL 3017
RAL 1003	RAL 1014	RAL 1023	RAL 2001	RAL 2012	RAL 3009	RAL 3018
RAL 1004	RAL 1015	RAL 1024	RAL 2002	RAL 3000	RAL 3011	RAL 3020
RAL 1005	RAL 1016	RAL 1027	RAL 2003	RAL 3001	RAL 3012	RAL 3022
RAL 1006	RAL 1017	RAL 1028	RAL 2004	RAL 3002	RAL 3013	RAL 3027
RAL 1007	RAL 1018	RAL 1032	RAL 2008	RAL 3003	RAL 3014	RAL 3031

RAL 4001	RAL 4009	RAL 5008	RAL 5017	RAL 6000	RAL 6008	RAL 6016
RAL 4002	RAL 5000	RAL 5009	RAL 5018	RAL 6001	RAL 6009	RAL 6017
RAL 4003	RAL 5001	RAL 5010	RAL 5019	RAL 6002	RAL 6010	RAL 6018
RAL 4004	RAL 5002	RAL 5011	RAL 5020	RAL 6003	RAL 6011	RAL 6019
RAL 4005	RAL 5003	RAL 5012	RAL 5021	RAL 6004	RAL 6012	RAL 6020
RAL 4006	RAL 5004	RAL 5013	RAL 5022	RAL 6005	RAL 6013	RAL 6021
RAL 4007	RAL 5005	RAL 5014	RAL 5023	RAL 6006	RAL 6014	RAL 6022
RAL 4008	RAL 5007	RAL 5015	RAL 5024	RAL 6007	RAL 6015	RAL 6024

RAL 6025	RAL 7000	RAL 7009	RAL 7022	RAL 7034	RAL 7043	RAL 8008
RAL 6026	RAL 7001	RAL 7010	RAL 7023	RAL 7035	RAL 7044	RAL 8011
RAL 6027	RAL 7002	RAL 7011	RAL 7024	RAL 7036	RAL 8000	RAL 8012
RAL 6028	RAL 7003	RAL 7012	RAL 7026	RAL 7037	RAL 8001	RAL 8014
RAL 6029	RAL 7004	RAL 7013	RAL 7030	RAL 7038	RAL 8002	RAL 8015
RAL 6032	RAL 7005	RAL 7015	RAL 7031	RAL 7039	RAL 8003	RAL 8016
RAL 6033	RAL 7006	RAL 7016	RAL 7032	RAL 7040	RAL 8004	RAL 8017
RAL 6034	RAL 7008	RAL 7021	RAL 7033	RAL 7042	RAL 8007	RAL 8019

RAL 8022	RAL 8028	RAL 9003	RAL 9011
RAL 8023	RAL 9000	RAL 9004	RAL 9016
RAL 8024	RAL 9001	RAL 9005	RAL 9017
RAL 8025	RAL 9002	RAL 9010	RAL 9018

 +351 244 616 210

 commercial@leirivedante.pt
geral@leirivedante.pt

 +351 963 424 018



 Scan me